

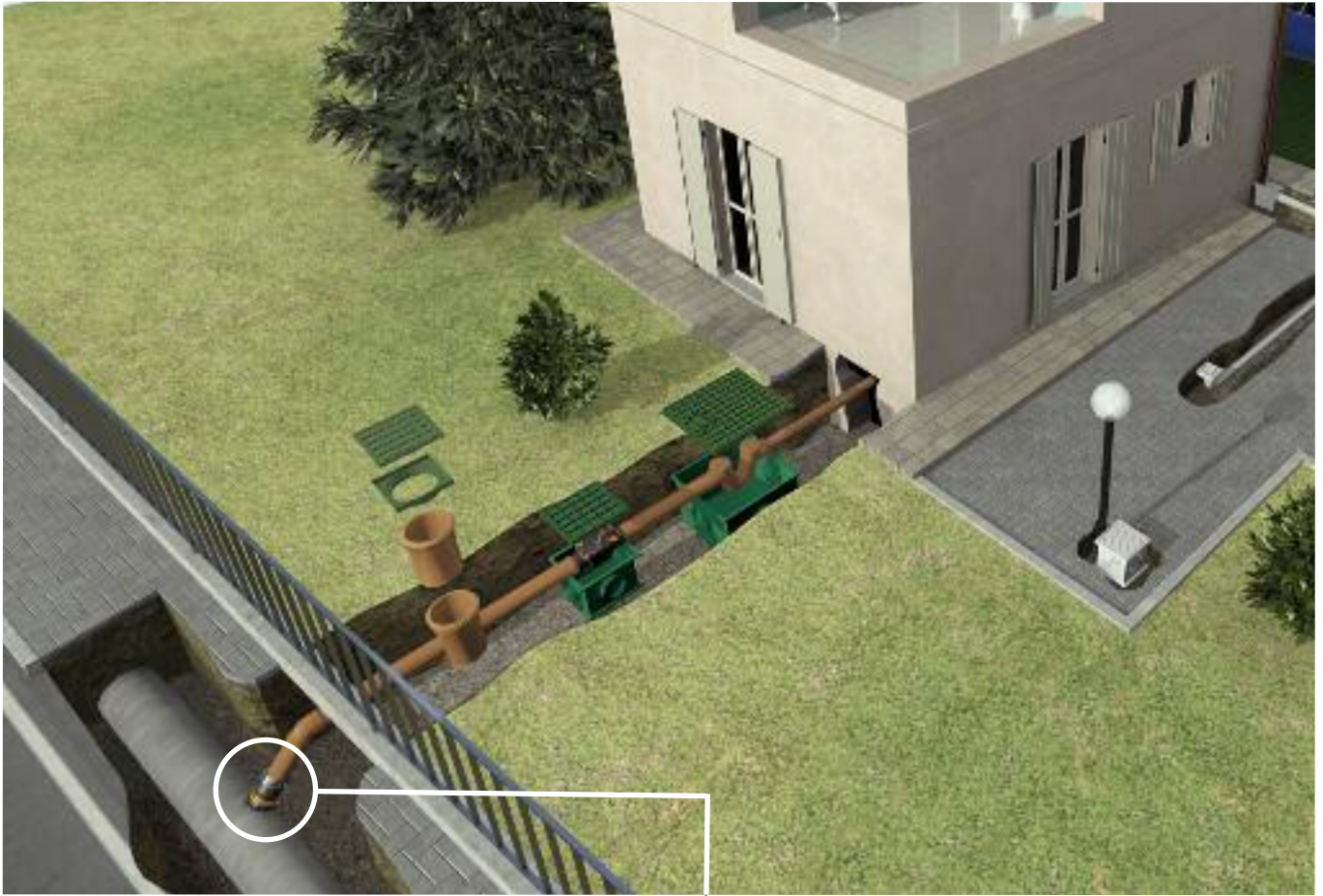



## Special mechanical connections

Easyclip, Mechanical Clip for PVC, Ceramic Clip, Swivel

# EASY CLIP



City 	Plus 	Link 	Tech 
 <p>Ø160</p>  <p>OD 200÷400</p>  <p>DN ID 250*</p>  <p>DN 200÷250</p> <p><b>For pipes with small diameters</b> *≥SN8 complying with EN 13476</p>	 <p>Ø160</p> <p>Spherical joint</p>  <p>OD 315÷1000</p>  <p>DN 300÷1200</p>  <p>DN 300÷1200</p> <p><b>For all materials, large diameters, absorbs the soil movements</b></p>	 <p>Ø160 Ø 200</p>  <p>OD 315÷1000</p>  <p>DN 300÷1200</p>  <p>DN 300÷1200</p> <p><b>For all materials, large diameters</b></p>	 <p>Ø160</p>  <p>DN 250-300-350</p>  <p>DN 250-300</p> <p><b>For Concrete and Clay pipes, for hard cleaning</b></p>

# Special mechanical connections

EasyClip mechanical saddles are products that provide connections to pipelines, without the use of adhesives, or cements. They are particularly suitable for:

### New installations

For carrying out a lateral connection to the sewage or drainage well.

### Pre-existing pipelines

They allow the creation of a new connection to a pre-existing sewer or drain, and are suitable for both foul and surface water.

**The range:** four products to suit different types of installation.



## City

### FOR SMALLER DIAMETER PIPES

Designed for Plastic compact solid wall pipes PVC/PP/PE Ø200-250-315-400.  
Vitrified Clay pipes Ø200, Ø250.  
Structured wall (smooth inside) pipes ID 250.  
Hole saw Ø152 mm.  
Socket rubber ring Ø160 mm.

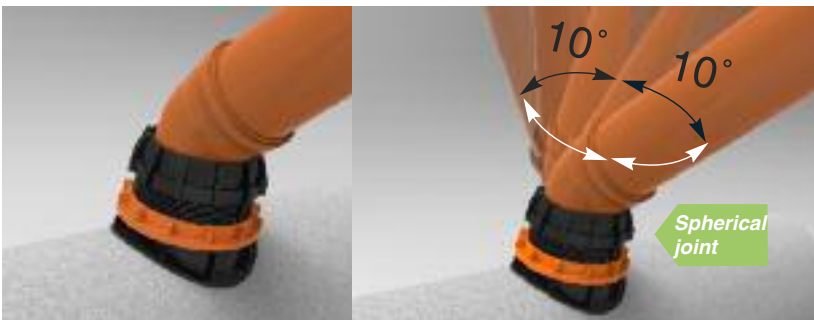

## Plus

### FOR LARGE DIAMETER PIPES

Suitable for any material pipe (plastic compact solid wall, plastic structured wall and smooth inside, concrete).  
From Ø300 up to Ø1200.  
Spherical joint (swivel) compensates ground movements.  
Socket Ø160 rubber ring.



## Link

### FOR LARGE DIAMETER PIPES

Suitable for any material pipe (compact solid wall, structured wall smooth inside, concrete).  
From Ø300 up to Ø1200.  
Either Ø160 or Ø200 socket rubber ring.



## Tech

### THICK WALLED CONCRETE & CLAY PIPES

Designed for thick walled concrete and clay pipes Ø250-350.  
No internal gaps and resistant to "hard cleaning cycles" (e.g. chains, blades, or high pressure water jetting).

# An alternative working method

With traditional collar-type systems, the main difficulty lies in removing the material beneath the existing pipeline. The EasyClip Connections provide for a completely different and more professional working methodology.

**The main advantages of using a mechanical connection can be summarized in the following points:**

- Major reduction of the time required for excavating and backfilling existing pipelines
- Speed of installation
- Installation without the use of sealants
- Ease of installation
- Low overall installation costs
- Guaranteed joint security
- Flexible solutions

Obviously, the pipeline does not have to be “supported”, as is the case with traditional collar-type alternatives. The device’s mechanical anchoring system simplifies the operation and drastically reduces the installation time.

**Safety:** curing times are not required (as there is no use of cement or adhesives) and the excavation can be immediately backfilled once the intervention has been completed. For this reason, there is no need to leave the excavation open on roads, pathways or residential areas. Therefore there is no need for the work site to be monitored or cordoned off in order to prevent any potential accidents, thus providing significant savings.

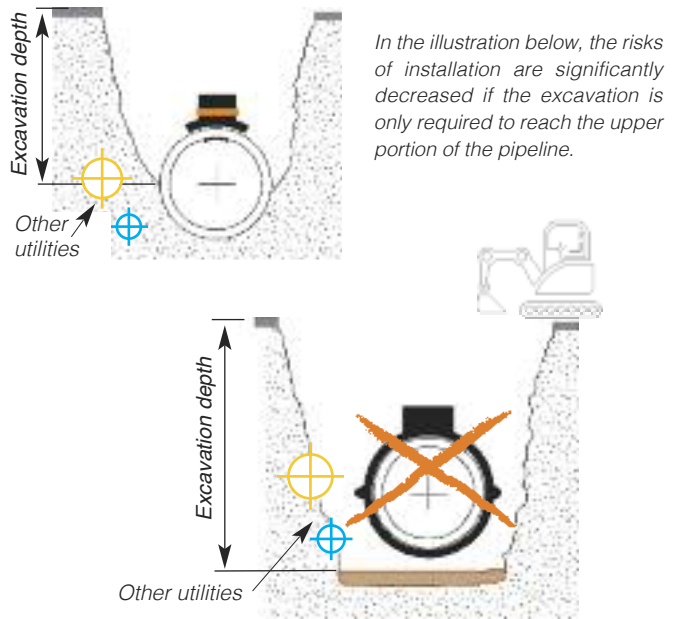
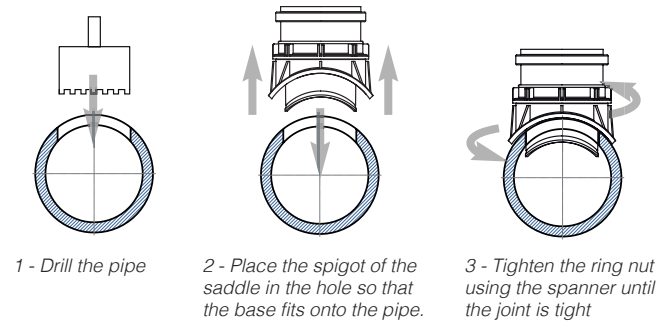

**With mechanical saddle**

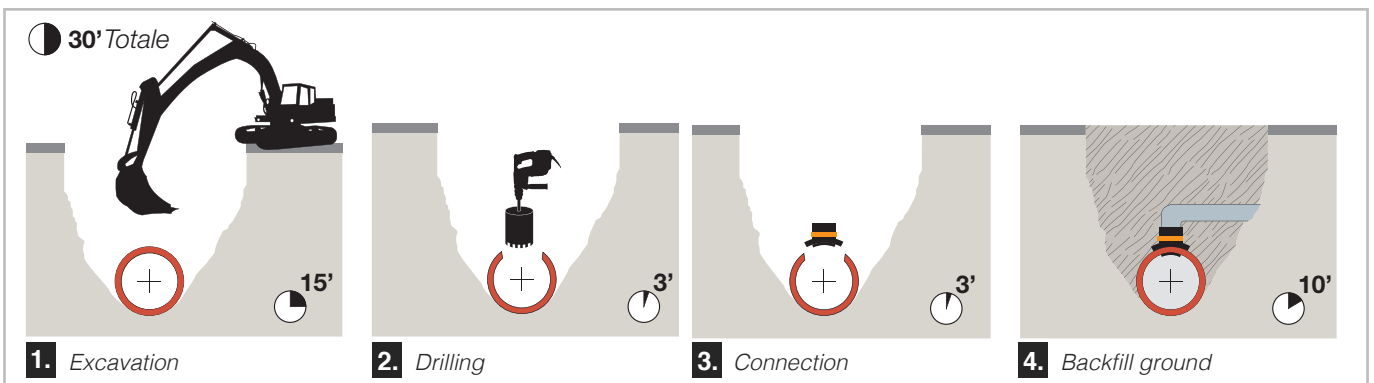

**Without mechanical saddle**

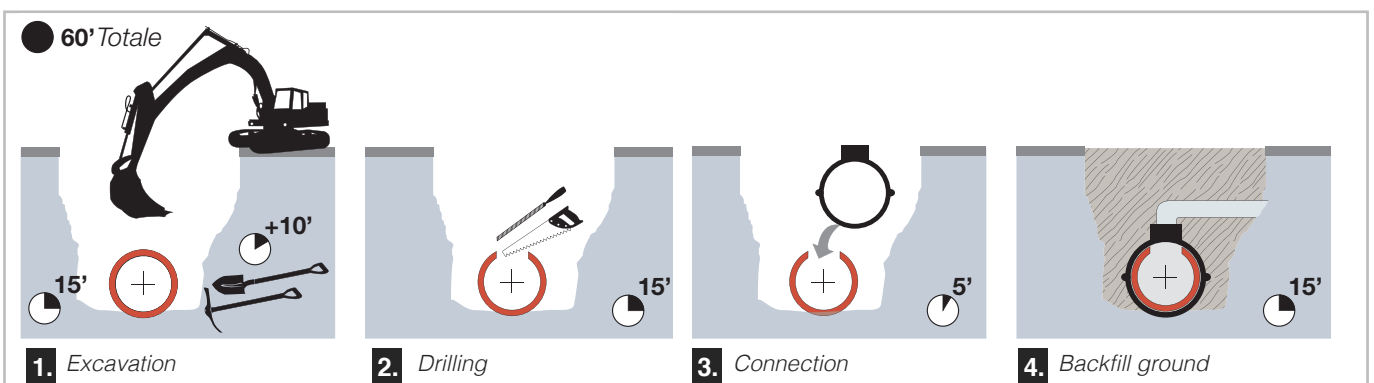

**Installation tips:**

- 1) Identify the point at which the connection is required and clean away any debris that may be present.
- 2) Drill the hole perpendicular to the axis of the main pipe

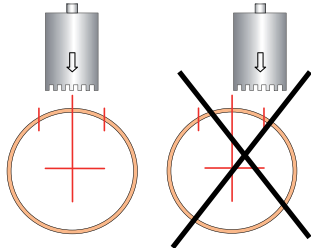

*Note:*  
 The use of appropriate equipment for centering the pipe will help to prevent errors during this phase.  
 The installation procedure will not be successful if the hole is performed in a decentralized manner.  
 In the case of non-plastic materials (i.e. ceramic or concrete) it is recommended to drill a guide hole (1) initially before completing the hole using a milling tool with a centring drill bit (2). The drilling procedure should always be carried out using water.  
 In the case of plastic materials, it is best to use a milling tool with an incorporated centring drill bit.

If more than one connection needs to be performed on the same tract of pipe, be sure to leave at least 1 meter between each hole.

The installation conditions must always be assessed on a case by case basis: loads, compactness of the terrain, presence of foundations, vehicular traffic, groundwater, etc.

- 3) Deburr the edges of the hole using a suitable tool, this is especially important for holes made in plastic materials.
- 4) Lubricate the seal.
- 5) Insert the Clip and tighten the ring nut.

**Installation Easyclip TECH:**

Easyclip tech is supplied with one or two adaptors and a spanner. Choose the right adaptor depending on the installation type. For detailed information concerning installation, please see the "installation sheet" contained in the box.

Fix the right adaptor using the supplied screws.

Easyclip Tech is ready to be installed.  
 i.e. on a concrete pipe.





EasyClip CITY is designed for installation onto smaller diameter pipes, usually in the “around the buildings applications”, both in residential and urban installations, on pipes sizes from Ø200 mm. It can be either used on foul or on surface drain/sewer of a single house or a dwelling.

EasyClip City is compatible with PVC pipes, plastic PE/PP structured wall (smooth inside) pipes, GRP (glass fibre reinforced plastic pipes), and vitrified Clay pipes. The City range delivers high performance for smaller applications whilst maintaining a competitive price.

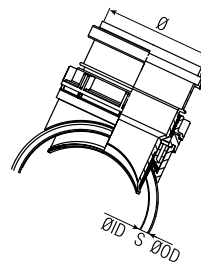

**ID = Internal Diameter**  
**OD = Outside Diameter**  
**S = Wall thickness**  
**DN = Nominal Diameter**

For different applications (other thickness/material) please contact: [export.redi@alixis.com](mailto:export.redi@alixis.com)

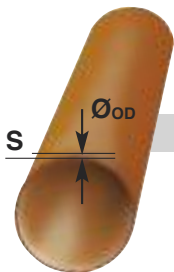

**Compact solid wall wall/multilayer smooth plastic pipes OD**

Pipe Ø OD	200	250	315	400
EasyClip City Ø160	1431158	1432258	1433358	1434458
S (mm)	3÷9	3÷15	3÷15	3÷18

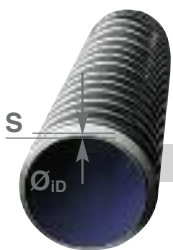

**Twin / structured wall plastic pipes ID**

Pipe Ø ID	Ø ID 250
EasyClip City Ø160	1432658
S (mm)	20÷30

Pipe conform to EN13476 ≥ SN8

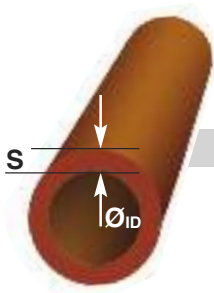

**Reinforced concrete and clay concrete**

Pipe DN	DN 200	DN 250
EasyClip City Ø160	1431658	1432658
Thickness Class According to EN 295-1	Class 160 / 240	Class 160 / 240
S (mm)	15÷28	20÷37



Installation on PVC/PP/PE compact solid wall pipes OD

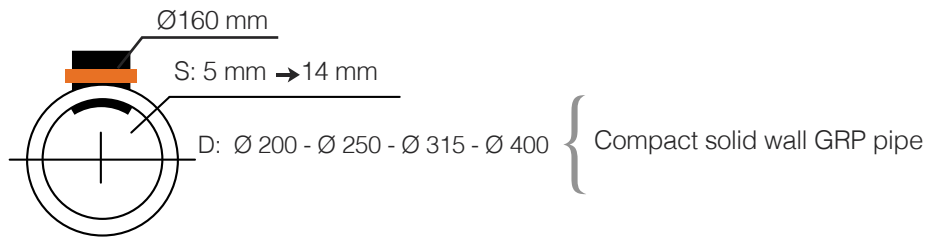

DN	Ø	S Max Pipe	L1	L2	Reference	Pack.	Hole saw
200	160	9 mm	255	195	1431158	1/10	AD1513P

\* 1 spanner included in each box of 6 pcs.

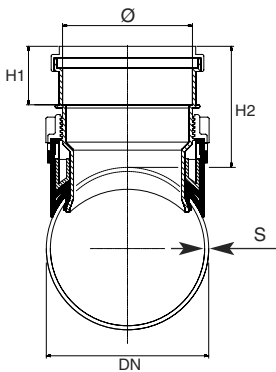

DN	Ø	S Max Pipe	L1	L2	Reference	Pack.	Hole saw
250	160	15 mm	285	290	1432258	1/48*	AD1513P
315	160	15 mm	315	290	1433358	6/48*	AD1513P
400	160	18 mm	360	290	1434458	1/48*	AD1513P

\* 1 spanner included in each box of 6 pcs.

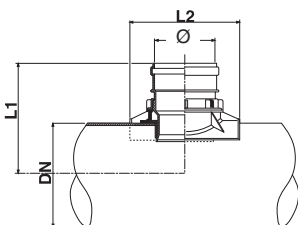

SPARE PARTS: EasyClip Spanner

DN	Reference	Note
160	0996606	

**City**  Installation on corrugated pipes ≥ SN8 ID 250 (complying EN13476)

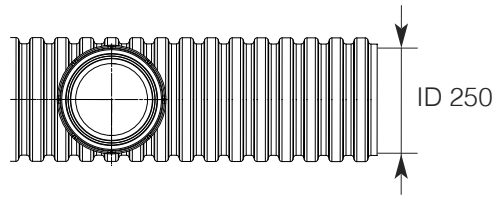
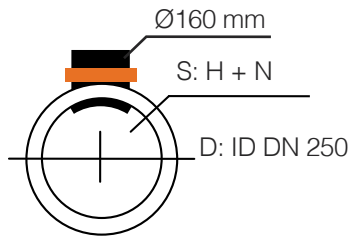

DN-ID	Ø	S Pipe Min. Max	L1	L2	L3	Reference	Pack.	Hole saw
250	160	20÷35	182	290	236	1432658	6/48*	AD1513P

\* 1 spanner included in each box of 6 pcs.

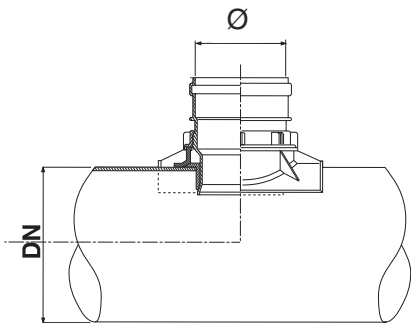

**SPARE PARTS: EasyClip Spanner**



DN	Reference	Note
160	0996606	



**City**  Installation on clay pipes DN 200/250

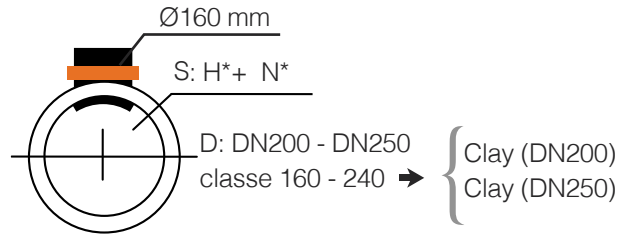

\*Thickness Class according to EN 295-1 N=160 H=240



	DN-ID	OD	Class	Ø KN/M <sup>2</sup>	H	L1	L2	L3	Reference	Pack.	Hole saw
Pipe standard	200	242	160	160	158	194	290	219	1431658	1/48*	AC1KSDZ
Pipe extra	200	254	240	160	152						
Pipe standard	250	299	160	160	161	182	290	236	1432658	1/48*	AC1KSDZ
Pipe extra	250	318	240	160	151						

\* 1 spanner included in each box of 6 pcs.  
Thickness class to EN 295-1

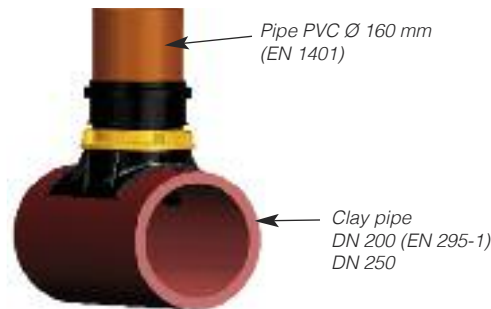
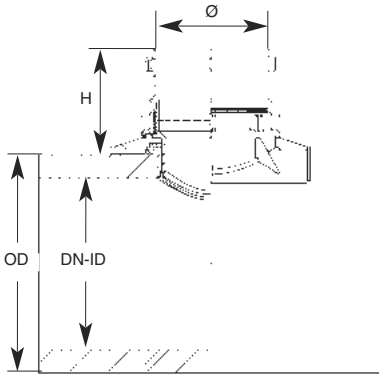

**SPARE PARTS: EasyClip Spanner**

DN	Reference	Note
160	0996606	



NOT AVAILABLE FOR SALE IN GERMANY



EasyClip LINK is perfect for connections to both sewage and drainage pipes. EasyClip Link provides the widest range of application possibilities and the best performance in terms of processing times and costs.

EasyClip Link is the traditional range suitable for meeting most of needs.

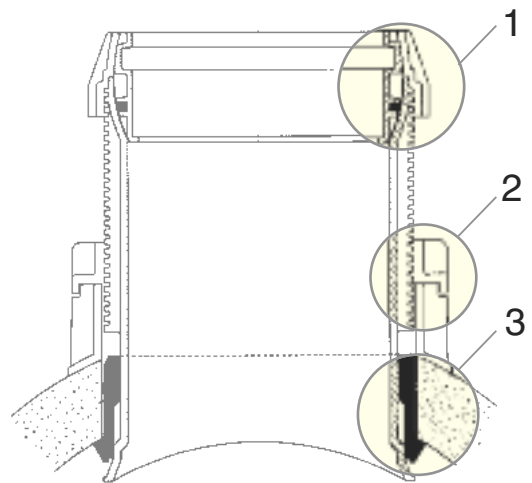
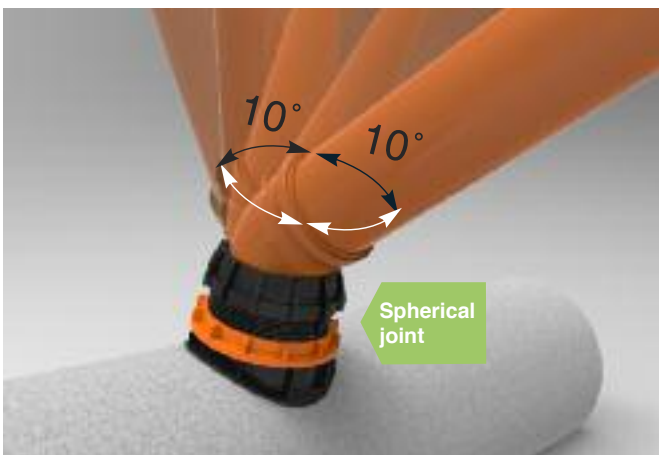

1) Smooth inlet Ø 160 mm with elastomeric seal. Dimensions according to EN 1401 nom.

2) The 160 mm swivel joint is pre-lubricated and ready-to-install (Patent No. EP 1548349 A1), and allows a rotation of  $\pm 10^\circ$  facilitate house connections and balance ground settlement. Installation instructions included in the packing.

3) Compression of the inner elastomeric expansion gasket (Patent No. EP 1548349 A1) allows easy insertion of the body into the main pipe. When compressed, the gasket ensures water tightness on every kind of material. Internal protrusion into the main pipe is minimal.

Pipe length 200 cms

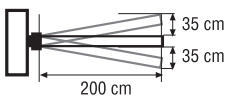

Pipe length 300 cms

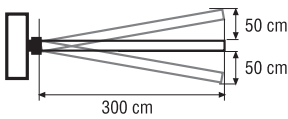

Pipe length 350 cms

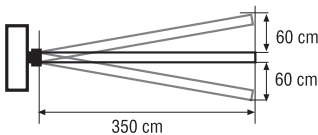

Pipe length 400 cms

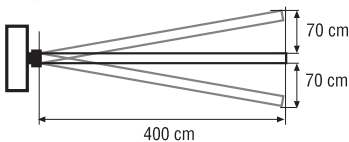

CSTB: EasyClip



MPA: EasyClip

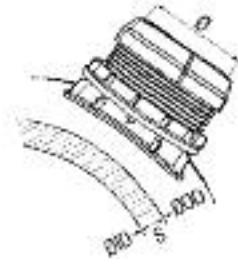

NOT AVAILABLE FOR SALE IN GERMANY

ID = Internal Diameter  
OD = Outside Diameter  
S = Wall thickness  
DN = Nominal Diameter

For different applications (other thickness/material) please contact:  
export.redi@alixis.com

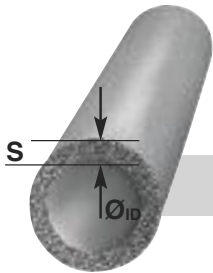

### Reinforced concrete

Pipe Ø ID		300	400	500	600	700÷1200
EasyClip Plus Ø160 with swivel		1C16058	1E16058	1H16058	1H16058	1K16058
S (mm)		30÷80	30÷80	40÷100	40÷100	40÷100

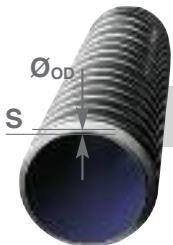

### Twin / structured wall plastic pipes OD

Pipe Ø OD		315	400	500	630	800÷1000
EasyClip Plus Ø160 with swivel		1A16058	1D16058	1G16058	1K16058	1K16058
S (mm)		5÷30	6÷35	9÷50	9÷50	20÷100
EasyClip Plus Ribassata Ø160 with swivel		1Y16058	1X16058	<b>Shorter version</b>		
S (mm)		5÷30	6÷35			

Pipe congorm to EN13476 ≥ SN8

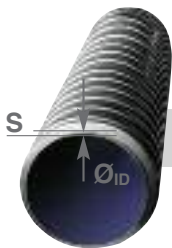

### Twin / structured wall plastic pipes ID

Tubo / Pipe Ø ID		300	400	500	600	700÷1200
EasyClip Plus Ø160 with swivel		1A16058	1E16058	1G16058	1H16058	1K16058
S (mm)		15÷30	30-80	20-65	40÷100	40÷100
EasyClip Plus Ø160 Shorter version with swivel		1Y16058	1Z16058	<b>Shorter version</b>		
S (mm)		15÷30	30÷55			

Pipe congorm to EN13476 ≥ SN8

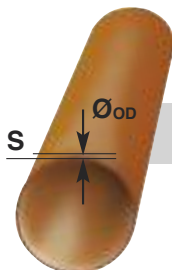

### Compact solid wall/multilayer smooth plastic pipes OD

Tubo / Pipe Ø OD		315	400	500÷630	710÷1000
EasyClip Plus Ø160 with swivel		1A16058	1D16058	1G16058	1J16058
S (mm)		5÷30	6÷35	9÷50	10÷60
EasyClip Plus Ø160 Shorter version with swivel		1Y16058	<b>Shorter version</b>		
S (mm)		5÷30			



**Installation on structured, Compact solid wall, Clay, Concrete and GRP pipes**

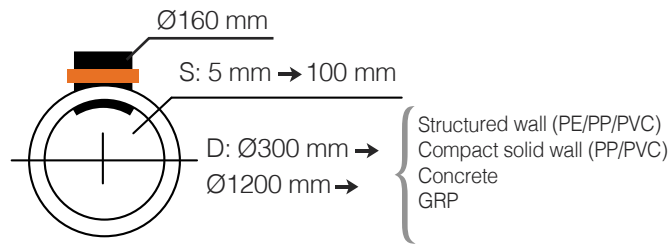

EasyClip Plus Ø 160 mm

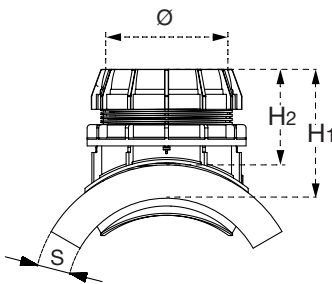

Ø (mm)	H1 (mm)	Reference	Certif.	Pack.	Hole saw (see pag. 243)
160	255	1A16058		1/38	AD2013P (for plastic)
160	255	1C16058		1/38	AC2CSDZ (for non plastic)
160	255	1D16058		1/38	AD2013P
160	255	1E16058		1/38	AC2CSDZ
160	255	1G16058		1/38	AD2013P
160	255	1H16058		1/38	AD2013P / AC2CSDZ
160	255	1J16058		1/38	AD2013P
160	255	1K16058		1/38	AD2013P / AC2CSDZ
160	205	1X16058		1/38	AD2013P
160	205	1Y16058		1/38	AD2013P
160	205	1Z16058		1/38	AD2013P

\* CSTBat certification on going

A spanner is supplied with each saddle

**Calculation:  $H_2 = H_1 - S$  ( $\pm 0,5$  cm)**  
**S= wall thickness**

**SPARE PARTS: EasyClip Spanner**



DN	Reference	Note
160	0995508	



Easyclip Link is perfect for sewage connections as well as for drainage pipes. Easyclip Link has the widest range of application possibilities and the best performance as features and costs ratio. Very fast in installation; it suits for the most of the cases for residential either not.

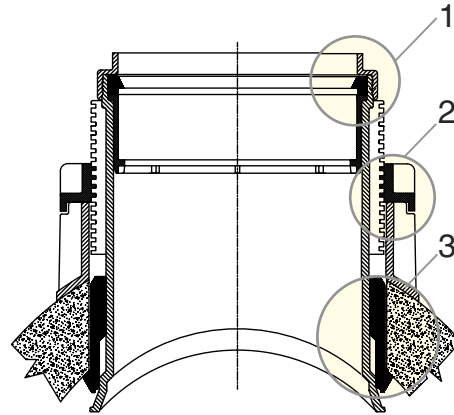

- 1) Smooth inlet  $\varnothing$  160 mm with elastomeric seal. Dimensions according to EN 1401 nom.
- 2) The 160 mm swivel joint is pre-lubricated and ready-to-install (Patent No. EP 1548349 A1), and allows a rotation of  $\pm 10^\circ$  facilitate house connections and balance ground settlement. Installation instructions included in the packing.
- 3) Compression of the inner elastomeric expansion gasket (Patent No. EP 1548349 A1) allows easy insertion of the body into the main pipe. When compressed, the gasket ensures water tightness on every kind of material. Internal protrusion into the main pipe is minimal.



CSTB: EasyClip



MPA: EasyClip

11. UDG SEWAGE FITTINGS

12. NON-RETURN VALVES

13. MECHANICAL SADDLES



ID = Internal Diameter  
 OD = Outside Diameter  
 S = Wall thickness  
 DN = Nominal Diameter

For different applications (other thickness/material) please contact:  
 export.redi@allaxis.com

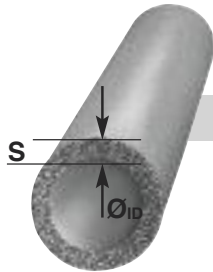

### Reinforced concrete, concrete and clay pipes ID

Pipe Ø ID	300	400	500	600	700÷1200
EasyClip Link Ø160	1C16L58	1E16L58	1H16L58	1H16L58	1K16L58
S (mm)	30÷80	30÷80	40÷120	40÷120	40÷120
EasyClip Link Ø200	1C20058	1E20058	1H20058	1H20058	1K20058
S (mm)	30÷80	30÷80	40÷100	40÷100	40÷100

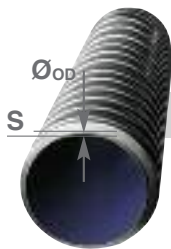

Pipe congorm to EN13476 ≥ SN8

### Twin / structured wall plastic pipes OD

Pipe Ø od	315	400	500÷630	800÷1000
EasyClip Link Ø160	1A16L58	1D16L58	1G16L58	1K16L58
S (mm)	5÷30	6÷35	9÷50	20÷100
EasyClip Link Ø200	1A20058	1D20058	1G20058	1K20058
S (mm)	5÷30	6÷35	9÷50	20÷100
EasyClip Link Ø160	1Y16L58	1X16L58	<b>Short version</b>	
S (mm)	5÷30	6÷35		
EasyClip Link Ø200	1Y20058	1X20058	<b>Short version</b>	
S (mm)	5÷30	6÷35		

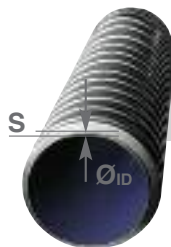

Pipe congorm to EN13476 ≥ SN8

### Twin / structured wall plastic pipes ID

Pipe Ø ID	300	400	500	600	700÷1200
EasyClip Link Ø160	1A16L58	1E16L58	1G16L58	1H16L58	1K16L58
S (mm)	15÷30	30÷80	20÷80	40÷120	40÷120
EasyClip Link Ø200	1A20058	1E20058	1G20058	1H20058	1K20058
S (mm)	15÷30	30÷80	20÷65	40÷100	40÷100
EasyClip Link Ø160	1Y16L58	1Z16L58	<b>Short version</b>		
S (mm)	15÷30	30÷70			
EasyClip Link Ø200	1Y20058	1Z20058	<b>Short version</b>		
S (mm)	15÷30	30÷55			

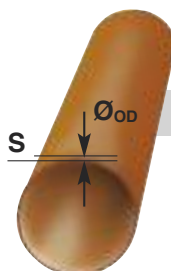

### Compact solid wall/multilayer smooth plastic pipes OD

Pipe Ø od	315	400	500÷630	710÷1000
EasyClip Link Ø160	1A16L58	1D16L58	1G16L58	1J16L58
S (mm)	5÷30	6÷35	9÷50	10÷80
EasyClip Link Ø200	1A20058	1D20058	1G20058	1J20058
S (mm)	5÷30	6÷35	9÷50	10÷60
EasyClip Link Ø160	1Y16L58	<b>Short version</b>		
S (mm)	5÷30			
EasyClip Link Ø200	1Y20058	<b>Short version</b>		
S (mm)	5÷30			



Installation on structured, Compact solid wall, Clay, Concrete and GRP pipes

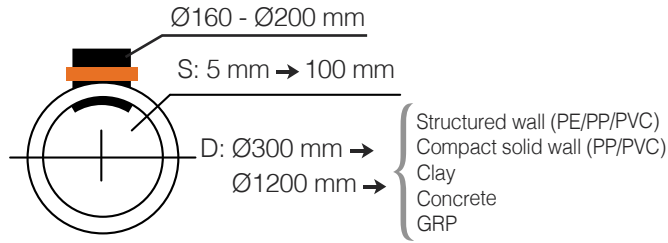

EasyClip Ø 160 mm

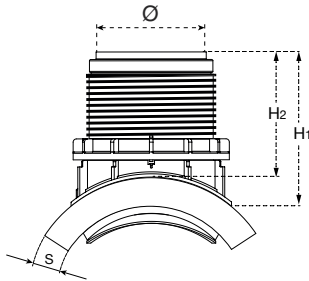

EasyClip Ø 200 mm

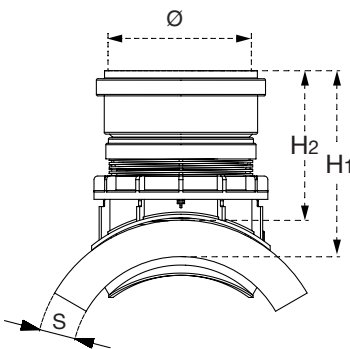

Ø (mm)	H1 (mm)	Reference	Cert.	Pack.	Hole saw (see pag. 243)
160	255	1A16L58		1/38	AD2013P (for plastic)
160	255	1C16L58		1/38	AC2CSDZ (for non plastic)
160	255	1D16L58		1/38	AD2013P
160	255	1E16L58		1/38	AC2CSDZ
160	255	1G16L58		1/38	AD2013P
160	255	1H16L58		1/38	AD2013P / AC2CSDZ
160	255	1J16058		1/38	AD2013P
160	255	1K16L58		1/38	AD2013P / AC2CSDZ
160	205	1X16L58		1/38	AD2013P
160	205	1Y16L58		1/38	AD2013P
160	205	1Z16L58		1/38	AD2013P
200	315	1A20058		1/38	AD2013P (for plastic)
200	315	1C20058		1/38	AC2CSDZ (for non plastic)
200	315	1D20058		1/38	AD2013P
200	315	1E20058		1/38	AC2CSDZ
200	315	1G20058		1/38	AD2013P
200	315	1H20058		1/38	AD2013P / AC2CSDZ
200	315	1J20058		1/38	AD2013P
200	315	1K20058		1/38	AD2013P / AC2CSDZ
200	265	1X20058		1/38	AD2013P
200	265	1Y20058		1/38	AD2013P
200	265	1Z20058		1/38	AD2013P

\* CSTBat certification on going

A spanner is supplied with each saddle

Calculation:  $H_2 = H_1 - S (\pm 0,5 \text{ cm})$   
 S = wall thickness

SPARE PARTS: EasyClip Spanner

Ø	Reference	Note
160	0995508	Closed
200	0996008	Open

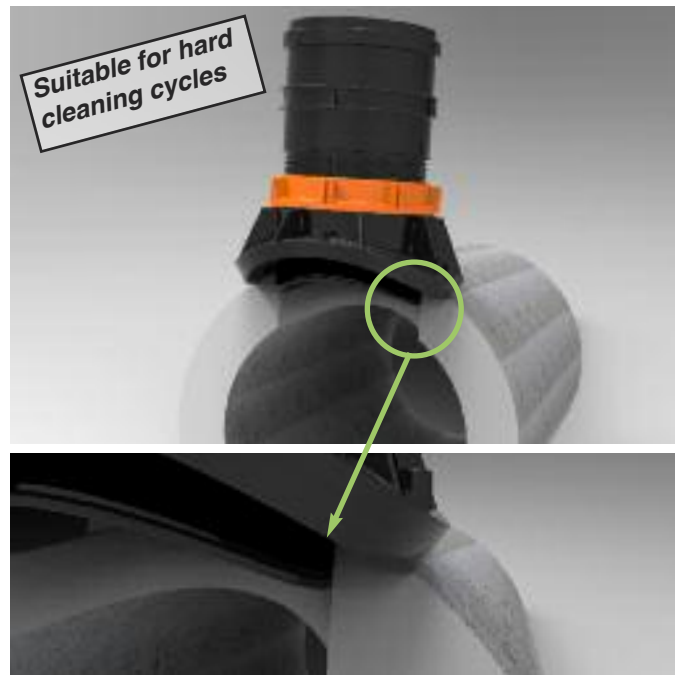

EasyClip TECH is especially designed for being installed on sewage and drainage pipes made of concrete or vitrified clay. The joint tightness is obtained by compression of saddle's tail. The spigot is fixed in the pipe wall without internal protrusion. This makes EasyClip Tech definitely suitable for particular operations, such as "hard cleaning cycles" (with chains, blades and high pressure water jetting).



**View from the inside of a clay pipe:**



- + **internal watertight seal**
- + **full through section**

*No internal protrusion on the gasket, resistant to hard cleaning.*

**Easyclip TECH Installation tips**

- EasyClip tech is supplied with one or two adaptors and a spanner.*
- Choose the right adaptor depending on pipe's wall thicknes.*
- Fix the right adaptor using the supplied screws, EasyClip Tech is ready to be installed. i.e. on a concrete pipe*
- For details concerning installation, please refer to the "installation sheet" contained in the box.*

**Clay pipes (Nominal diameter)**

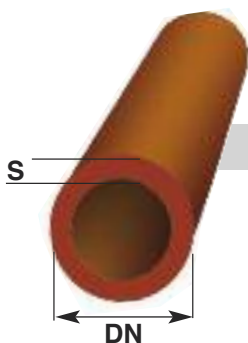

Pipe DN	250	300	350
Clay*	1T21658	1T11658	1T11658
S (mm)	Min. 23	Min. 23	Min. 23

*\* Dimensions according to the EN295-1*

**Reinforced concrete pipes**

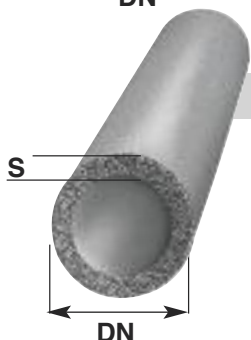

Pipe DN	250	300
Concrete	1T11658	1T11658
S (mm)	Min. 23	Min. 23

*For different applications (other thickness/material) please contact: [export.redi@alixis.com](mailto:export.redi@alixis.com)*



# Tech Installation on Concrete and Clay

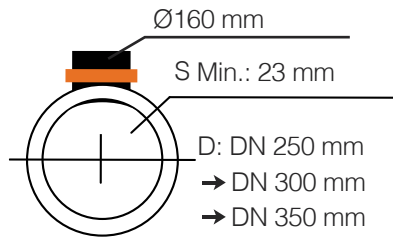

Ø (mm)	H (mm)	Reference	Pack.	Hole saw (see pag. 243)
160	260	1T11658	1/38	ACTKSDZ (for non plastic pipes)
160	260	1T21658	1/38	ACTKSDZ (for non plastic pipes)

**H = Ledge EasyClip installed on tube**

*A Spanner is supplied with each saddle.*

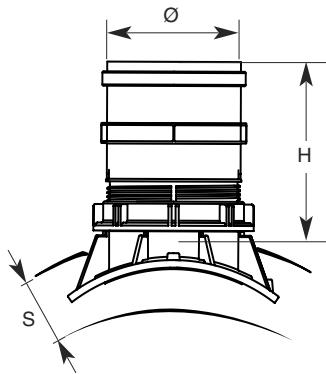

**Note:**

Designed for concrete and clay pipes DN 250, 300, 350.  
 With high thicknesses.  
 Without internal gaps.  
 Resistant to the sewage "hard cleaning cycles" (e.g. chains, blades, or hi pressur waterjet).

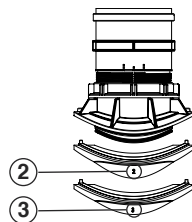
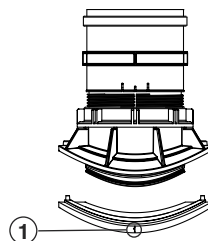

## Adaptors

Cod. 1T11658			
Clay Grés	DN 300	N - Class 160* H - Class 240*	①
	DN 350	N - Class 160* H - Class 240*	NO
Concrete Beton	DN 250		①
	DN 300		NO

Cod. 1T21658			
Clay Grés	DN 250	N - Class 160*	②
	DN 250	H - Class 240*	③

## SPARE PARTS: EasyClip Spanner



DN	Reference	Note
160	0996606	



**Compact inverter reducer**  
*Compacta*

DN	DN1	DN2	H	H1	S	Reference Black	Pack.	Note
110	160	166	69.5	57	4	0686348	1/20	

Material: PVC-U

Gasket: locked premonted EN681

Dimensions complying EN1401/EN1329

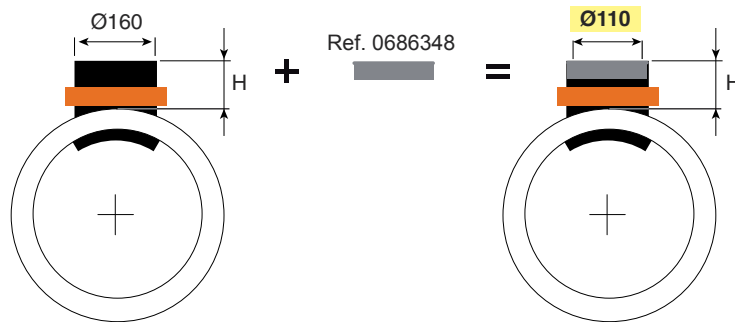
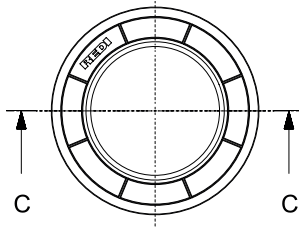
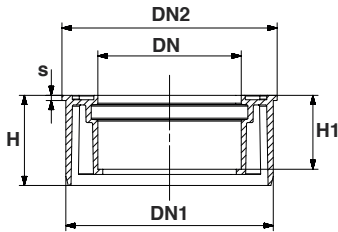

**Recommended for installation on Easyclip City, Link and Tech**

**Reference**  
143ID58  
1432658  
1431658

**City**

**Reference**  
1A16L58  
1C16L58  
1D16L58  
1E16L58  
1G16L58  
1H16L58  
1J16L58  
1K16L58  
1X16L58  
1Y16L58  
1Z16L58

**Link<sub>160</sub>**

**Reference**  
1T11658  
1T21658

**Tech**

**Not for installation on EasyClip Plus**

## Equipment

## Hole saw for plastic pipes

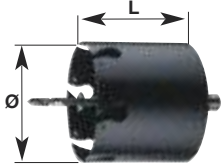

DUSS made in Germany

Ø (mm)	L (mm)	Mandren	Pilot bit	Long endurance	Reference	Pack.	Note
200	163	13mm	✓	✓	AD2013P	1	Pipes from Ø250
152(6")	163	13mm	✓	✓	AD1513P	1	Pipes from Ø200

**Suitable for drilling materials:** PVC / PP / PE / GRP (sand free)

## Hole saw for non plastic pipes

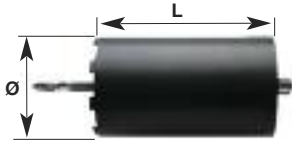

DUSS made in Germany

Ø (mm)	L (mm)	Mandren	Pilot bit	Long endurance	Reference	Pack.	Note
202	300	SDS max	✓	✓	AC2CSDZ	1	Pipes from Ø250
172	300	SDS max	✓	✓	ACTKSDZ	1	
152(6")	300	SDS max	✓	✓	AC1KSDZ	1	

**Suitable for drilling materials:**

Reinforced concrete / Reinforced corrugated steel / Fiber glass filled with sand / Clay

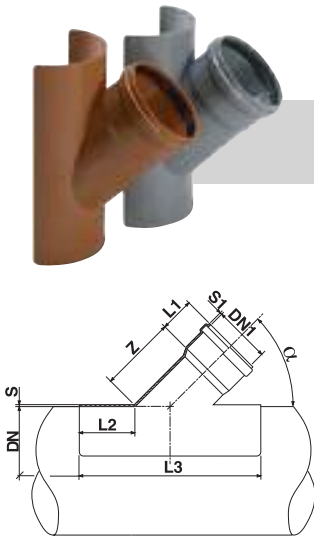

**Saddle SCJ 45°**  
Clip à coller 45°

DN	DN1	$\alpha$	S	S1	Z	L1	L2	L3	Reference RAL 7037 Grey	Reference RAL 8023 Red	Pack.
160	125	45°	3.2	3.0	128	62	65	300	0438042	0438091	
200	125	45°	4.1	3.0	128	62	85	340	0438242	0438291	
200	160	45°	4.1	3.6	165	73	85	390	0438442	0438491	
250	125	45°	5.5	3.0	128	62	92	350	0438642	0438691	
250	160	45°	5.5	3.6	165	73	92	400	0438842	0438891	
315	125	45°	5.5	3.0	128	62	92	350	1439042	1439091	
315	160	45°	6.9	3.6	165	73	110	432	0439442	0439491	
315	200	45°	6	4.4	236	95	86	513	1433242	1433291	
400	125	45°	5.5	3.0	128	62	92	350	1439142	1439191	
400	160	45°	5.5	3.6	165	73	92	400	1439542	1439591	
500	125	45°	5.5	3.0	128	62	92	350	1439242	1439291	
500	160	45°	5.5	3.6	165	73	92	400	1439642	1439691	

Fixed Ring Lip Ring

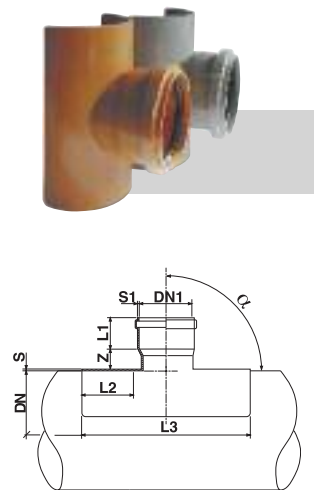

**Saddle SCJ 90°**  
Clip à coller 90°

DN	DN1	$\alpha$	S	S1	Z	L1	L2	L3	Reference RAL 7037 Grey	Reference RAL 8023 Red	Pack.
200	160	90°	4.4	3.6	34	58.5	77	322	0434342	0434351	
250	160	90°	4.4	3.6	34	58.5	77	322	1424242	1424251	
315	160	90°	-	-	-	-	-	-	-	142525E	
315	200	90°	6	4.4	45	86	75	390	1425552	-	
400	160	90°	-	-	-	-	-	-	-	142625E	

Fixed Ring Lip Ring

# Algopipe 4.0

Progettazione integrale degli impianti



## Complete planning of sanitary and sewage systems

REDI is introducing the new "Algopipe" 4.0: a multitasking calculation software for mechanical systems sizing.

This software is addressed for the professionals who are usually involved in sanitary and sewage systems design.

"Algopipe" has been conceived for the professional who is requested to quickly find technical and economic solutions for both preliminary and final estimates; for enterprises facing problems in working out estimates and calculations; for technicians aiming to give a better service to their customers and to be sure to choose the right product.

"Algopipe" 4.0 combines 5 specific tools in one console for the sizing of:

- Sanitary systems,
- UFH (under floor heating)
- Soil and waste networks and drainage systems
- Soil drainage



## Algopipe 4.0

Free download [www.redi.it](http://www.redi.it)