



Thermostatic valves are a cheap and reliable thermoregulation solution for reducing energy consumption.

The built in liquid sensor regulates and keeps the room temperature to the pre-set value.

The thermostatic valves must be installed far from any object, such as shelves, curtains or furniture, which may interfere with the temperature detection.

TECHNICAL DATA:	Max working pressure:	10 bar
	Max working temperature:	120 °C
	Max differential pressure:	1 bar
	Max room temperature:	40 °C

CONSTRUCTION FEATURES:	Sensor:	Liquid
	Hysteresis:	< 0.4 K
	Response time (Z):	22 min.
	Influence of water temperature (W):	0.25 K
	Inalterability range:	-15 °C ÷ +50 °C
	Storage temperature:	-15 °C ÷ +50 °C
	Intermediate position:	Pos. "3" = 20 °C
	Head material:	ABS chrome
	Ferrule material:	CW 614 N UNI-EN 12164-98

DIMENSIONAL DRAWINGS

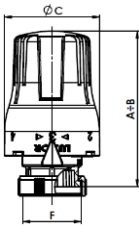
	Article:		TT 3000C								
	Description:		Thermostatic head with built in sensor								
	Connection:		-								
	Code	Size	A	B	C	D	E	F	G	H	L
	69100000C	M30x1.5	75	80	46,5	-	-	M30x1.5	-	-	-

CONTROL ADJUSTMENT SCALE

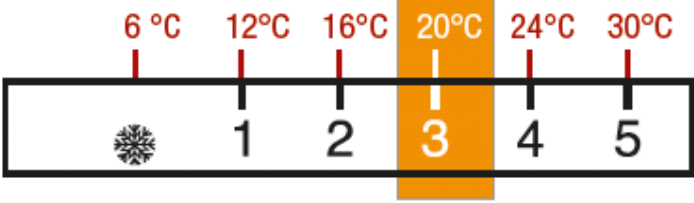

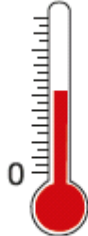



OPERATION:

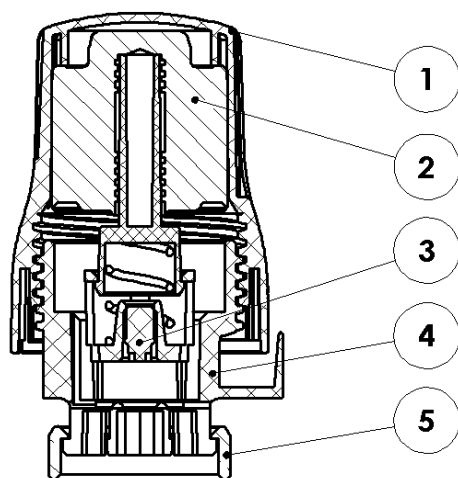

- 1. Regulation knob
- 2. Liquid sensor
- 3. Rod
- 4. Body
- 5. Fixing ferrule

The thermostatic valve is a proportional temperature controller with a sensor (2) filled with high expansion liquid. This liquid, placed inside the regulation knob (1) can proportionally expand and diminish in accordance with the increase or reduction of the room temperature. When the room temperature increases the liquid inside the bellows expands pushing the valve control stem down against the return spring. This closes the valve reducing fluid flow to the radiator to cool the room proportionally to the set temperature. When the temperature decreases there is an opposite action, the bellows contracts and the valve spring opens the valve increasing the fluid flow to the radiator to warm the room. The thermostatic heads keeps the room temperature constant which means guaranteed energy savings. By regulating the knob it is possible to set the required value, the numbers indicate the temperature value as shown in the control adjustment scale.

OPERATING INSTRUCTION

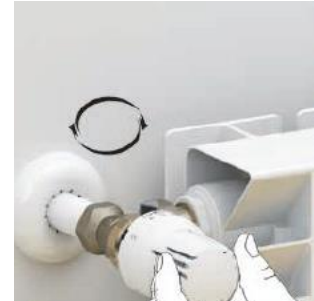

Before installation select position "5" on the valve knob. Unscrew the white protection cap of the thermostatic valves series Thermo Tekna. Screw the Thermostatic valve and select the required temperature.

KNOB LIMIT/LOCKING



Picture 1



Picture 2



Picture 3

It is possible to limit or block the temperature of the valve using the limiters provided in the box. If the position required is 3, first rotate the head to match number 3. At the bottom there is a spline, when inserting the limiter across this spline the temperature will be blocked (picture 1), Inserting the limiter on the left of the spline the limit will be from value 3 to 5 (picture 2) while when inserting the limiter on the right the limit will be from 3 to * (picture 3).

FOR A CORRECT FUNCTIONING

Picture 1

Picture 2

Picture 3

Picture 4

Picture 5

Picture 6

The thermostatic heads must be installed far from the heating flow of the radiator (picture 1), never under direct sun light (picture 2). Do not install under shelves or hollow space (pictures 3 and 4) within the air flow (picture 5) behind curtains (picture 6).

For correct functioning it is advisable to install a safety valve between flow and return.

To avoid excessive noise, do not use thermostatic valves with value ΔP higher than 0.2-0.25.

TENDER SPECIFICATIONS
Article code
69100000C

Thermostatic head energy efficient with control knob and liquid sensor. Regulation scale from antifreeze "❄" to "5", corresponding to a regulation range from 6° to 30°C. Possibility to limit or block the temperature.

TT 3000C